

Manual

CI74 Controller

Single Actuator Controller in Modbus-RTU

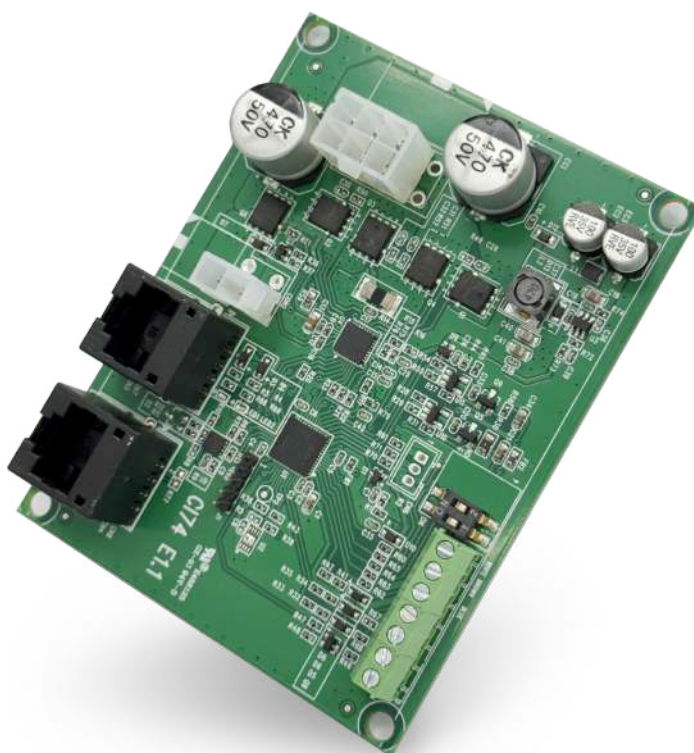

Revision	2025.10_V1.3
-----------------	--------------

Technical changes may be made to improve the product without notice !

Table of Contents

1. Overview	3
2. Important Information	3
3. General	4
3.1 Symbol description	4
3.2 Features and Options	4
3.3 Transport and Storage	5
4. Precautions before Installation	5
5. System Diagram	6
6. Hardware I/O	7
6.1 Power input	8
6.2 Actuator connector	8
6.3 Supplementary control I/O	9
6.3.1 Options of CI74 control I/O	9
6.3.2 Behavior of Stroke Learning Function	10
6.4 PC setting ports	10
6.5 Bus communication ports	11
6.6 Operation indicator	12
6.7 Setting switches	13
6.7.1 Lock/Unlock of setting function	13
6.7.2 Override	13
7. Installation Steps / Operating Instructions	14
8. Motack CI74 PC Tool	15
8.1 Basic setting	15
8.1.1 Automatic configuration	15
8.1.2 Change device ID	16
8.2 Configuration of actuator parameters	17
8.2.1 Learning for actuator stroke	18
8.2.2 Configuration for CI74-D & CI74-B	19
8.2.3 Configuration for CI74-P	20
8.3 Parameters management function	21
8.3.1 Read	21
8.3.2 Export	21
8.3.3 Import	22
8.4 Control function	24
8.4.1 For CI74-D or CI74-B	24
8.4.2 For CI74-P	24
9. Modbus Protocol	25
9.1 General information	25
9.2 Message format	25
9.3 Register table and application example	28
9.3.1 Parameter list of Holding Register	29
9.3.2 Parameter list of Input Register	30
9.3.3 Application example	31
9.4 Exception message	35

1. Overview

CI74 is a controller suitable for industrial applications. It allows the customer's PLC/PC host controller to control the actuator using commands that comply with the Modbus RTU communication protocol through the RS-485 network. Each CI74 only controls one actuator, but multiple CI74s can be connected using the CAT-5 or higher network cables to form a multi-actuator control system, and the number of actuator groups can be added flexibly. The use of bus communication makes wiring brief, and because CI74 is widely compatible with Moteck's mainstream DC actuator models, it is possible to integrate simple DC actuators into the user's existing Modbus control network through CI74 control board.

2. Important Information



- (1) Only qualified personnel are allowed to carry out the mechanical and electrical installation of this product. Qualified personnel should be familiar with the mechanical or electrical installation work and have corresponding work qualifications.
- (2) Please read this manual before installing or operating the controller.
- (3) Do not perform mechanical installation while power is on. Complete the mechanical installation first, and then connect the power supply.
- (4) Installers and operators must wear personal safety protection according to the site conditions. And before starting to control the action of the actuator, it must be noted that the actuator and its connected mechanical moving parts are not blocked by other objects, and no one enters the dangerous area.
- (5) Strictly follow the information in this manual, and do not exceed the range of the specification.
- (6) Never disconnect any wires or connectors during operation or when power is applied.
- (7) The error message CI74 will feedback to the Modbus controller is on page 35, please refer to it. If you find the controller any malfunction or damage, please stop using it immediately and notify qualified personnel.



3. General

3.1 Symbol description

Symbol	Description
	This symbol indicates important information, reminders, or safety warnings.

3.2 Features and Options

- Input voltage: 12~29V DC (same as actuator power output)
- Actuator power output: Same as input voltage
- Max. current: 16A
- Max. number of actuator: 1 channel
- Control platform: Modbus RTU communication protocol
- Function version: CI74-D / CI74-P / CI74-B, there are three function options in this model.
(For CI74-P, the actuator's motion control can only be controlled through I/O terminals and cannot be controlled through Modbus messages; CI74-B is just the opposite and can only be controlled through Modbus messages.)
- Supports single Hall or dual Hall effect sensors (NPN type only) positioning feedback
- Supports actuators with or without stroke limit switches
- Provides Moteck CI74 PC tool for setting parameters and control actuators.
- 1500mm long USB to RJ45 PC setting cable
(Users must have at least one, please purchase separately.)
- LED operation indicator
- Duty cycle: 25%, max. 2 min. continuous operation in 8 min.
- Operating ambient temperature: -20°C~+55°C
- Storage ambient temperature: -40°C~+70°C
- Comes with 4 plastic PCB spacers
- Comes with a 100mm power cord
- Optional:
 - DIN rail holder (for mounting on DIN NS 32 or NS 35/7.5 rail)
 - 0.25W 120Ω terminating resistor (see section 6.5 for usage. Available for purchase as needed)
- Certified: CE Marking, EMC Directive 2014/30/EU.

Note: For more information, please refer to CI74 Product Data Sheet on MOTECK official website.



3.3 Transport and Storage

Please use the original packaging provided by MOTECK to transport and store the controller. The temperature during transportation and storage must be between $-40^{\circ}\text{C}\sim 70^{\circ}\text{C}$ ($-40^{\circ}\text{F}\sim +158^{\circ}\text{F}$) and the cargo must be protected from collision. If you find that the packaging of the delivered goods is damaged, please check whether the controller inside are obviously damaged, and notify the transporter. If necessary, please contact the shipper or seller to discuss the disposal.

4. Precautions before Installation



- (1) Before using each CI74 for the first time, be sure to turn on the parameter setting switch according to the actuator specifications (see section 6.7), then use the PC setting cable to connect to the PC for setting, and use the PC tool program provided by our company to complete the electronic installation and parameter setting (see section 8.1 & 8.2) before connecting to the host controller to start using it.
- (2) Each CI74 only controls one actuator that is directly connected to it. Each CI74 in a multi-actuator control system is independent of each other, so the connected actuators are also independent of each other. It is not limited to whether they are the same model, specification, or size.
- (3) The actuator does not have to be equipped with a physical limit switch, but the software must be set correctly on the CI74 to be connected.
- (4) Retract all actuators to the end before installation.
- (5) After connecting the individual actuator to the assigned CI74, electronic installation, and [Learning for actuator stroke] steps must be completed before its movement can be tested.
- (6) During a power outage to the CI74, as long as the actuator has not been replaced or moved, there is no need to relearn the stroke. If the CI74 is replaced, please follow the installation steps to reset the CI74, but it has nothing to do with the settings of other CI74 in the system.
- (7) Prepare a 12 or 24VDC power supply with sufficient power according to the specifications and quantity of actuators.



5. System Diagram

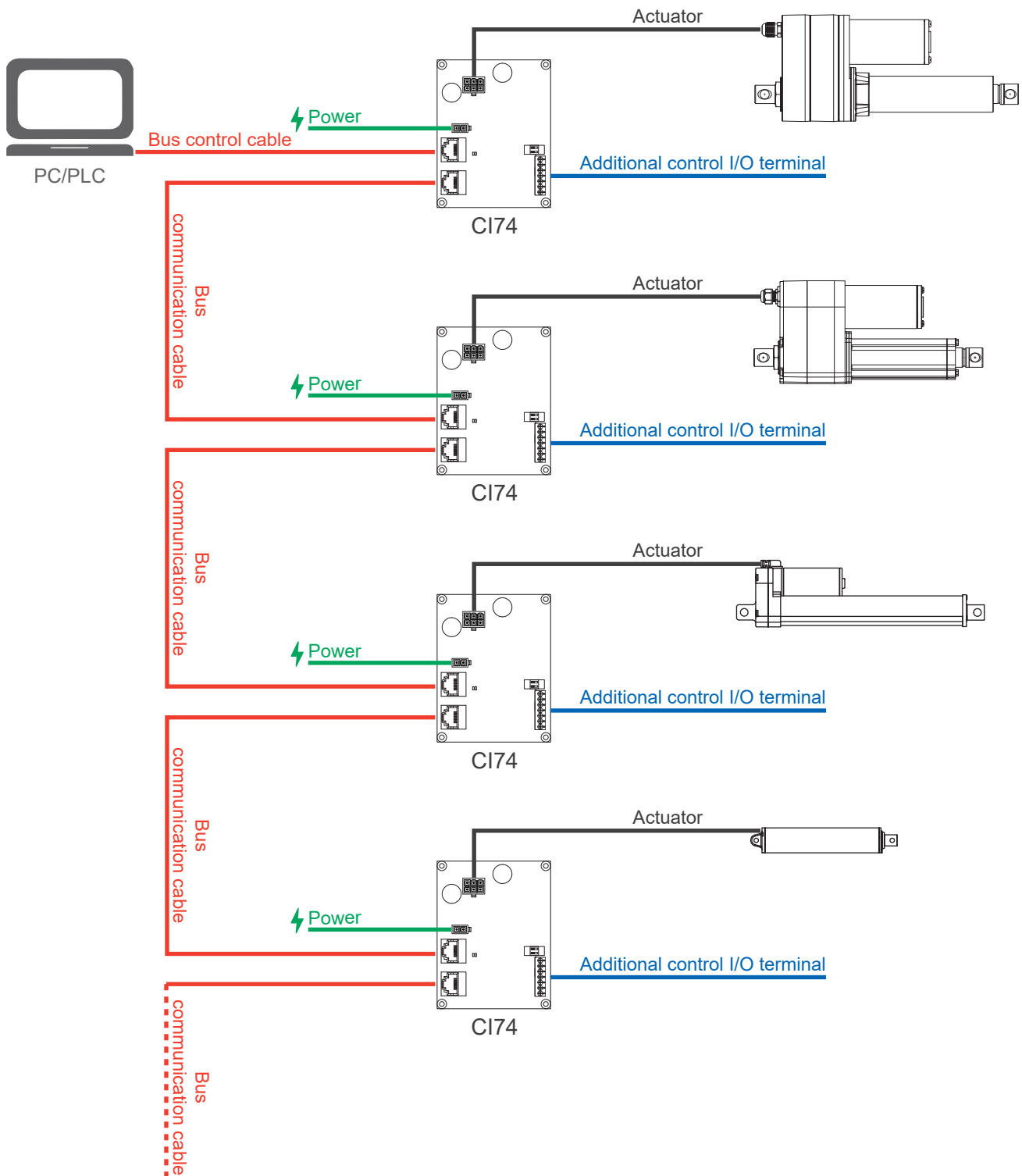

6. Hardware I/O



- Pay attention to insulation protection during installation to avoid possible risks and hazards for users to touch.
- Please confirm the actuator specification before connecting.

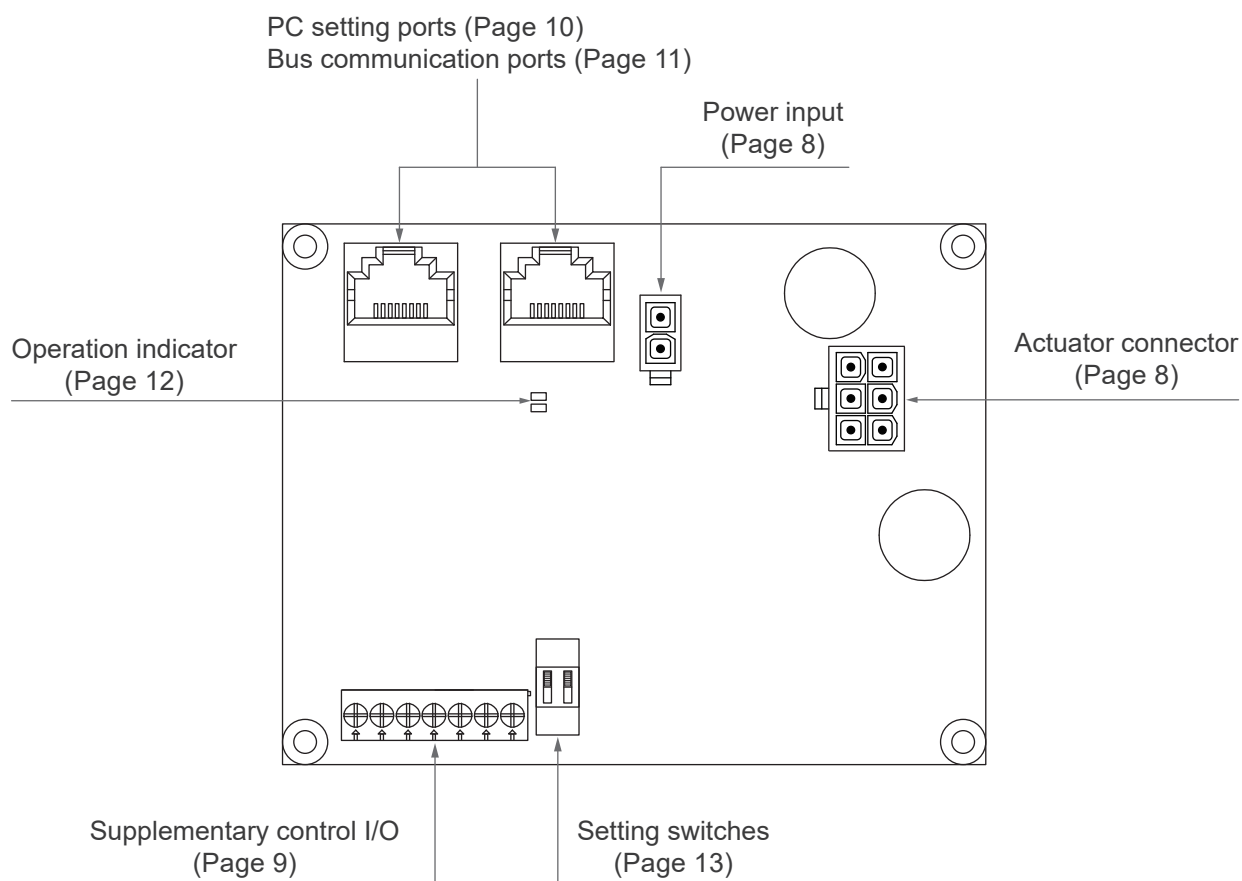

6.1 Power input

Definition	Description
V+	<ul style="list-style-type: none"> Nominal 24V DC (Acceptable input voltage range 22~25V DC) ; 12V DC (Acceptable input voltage range 11~13V DC) Recommend to use a 16AWG wire (Depending on the current)
V-	<ul style="list-style-type: none"> GND Recommend to use a 16AWG wire (Depending on the current)

Note:

The product comes with a short power cord that converts from a minifit plug to a 2-core flying lead. If necessary, users can arrange extended power wiring by themselves.

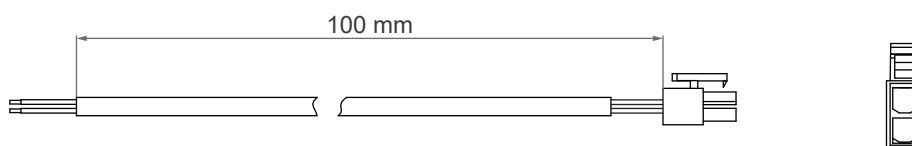

6.2 Actuator connector

Definition	Description	
M+	<ul style="list-style-type: none"> 24V DC output, 12.5A max ; 12V DC output, 16A max. When controlling the actuator to extend, M+/M- are VDC+/VDC- respectively. When retracting the actuator, the polarity is reversed. 	
M-		
G	GND	
Vcc	10V power output, for actuator's Hall module. Current max. 15mA	
H2	Hall 2 signal input	Signal phase diagram: (When actuator extends) <ul style="list-style-type: none"> A-type B-type <p>Both types are acceptable</p>
H1	Hall 1 signal input	

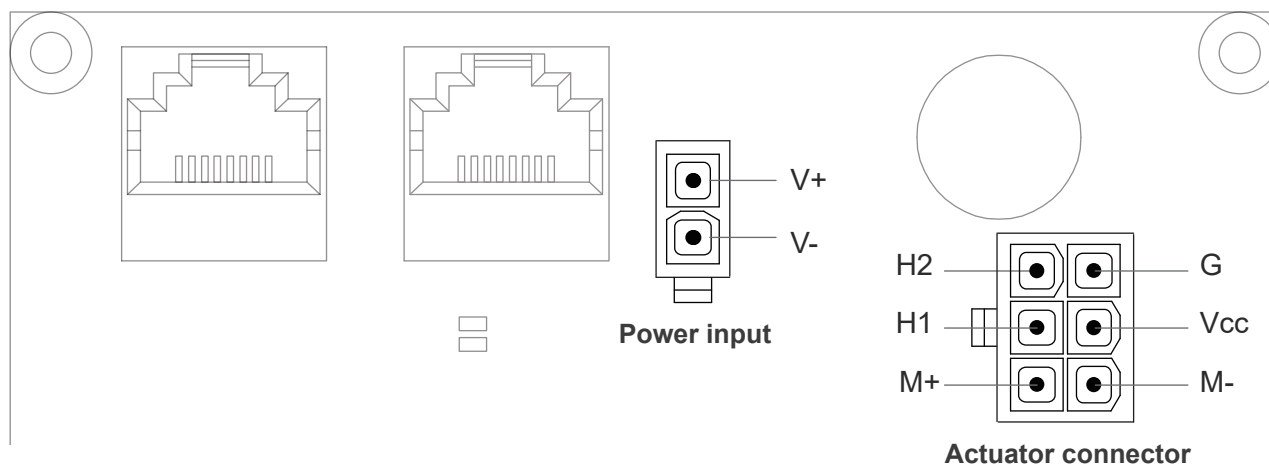

6.3 Supplementary control I/O

6.3.1 Options of CI74 control I/O

CI74 has three functional versions. The terminal definitions are as follows.

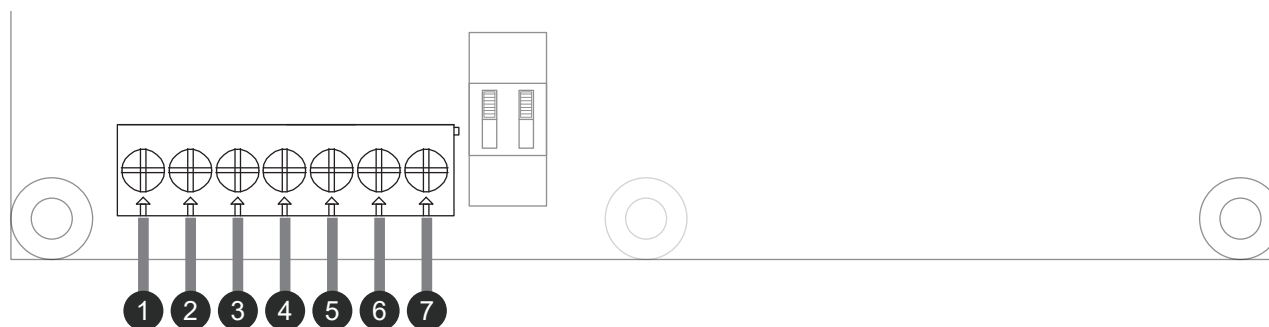

Pin No.	Function version		
	CI74-D Direction Control & Absolute Position Output	CI74-P Position Control & Arrival Signal Output	CI74-B Bus Control & Error Signal Output
①	Analog position output ⁽¹⁾	Analog position output ⁽¹⁾	Analog position output ⁽¹⁾
②	-	Reference voltage output ⁽²⁾	-
③	-	Analog position input ⁽³⁾	-
④	GND	GND	GND
⑤	Actuator retracts ⁽⁴⁾	Stop input ⁽⁵⁾	Stop input ⁽⁵⁾
⑥	Actuator extends ⁽⁴⁾	Position OK output ⁽⁶⁾	Error output ⁽⁷⁾
⑦	Learning ⁽⁸⁾	Learning ⁽⁸⁾	-

Notes:

- (1) Position output is an analog signal that reflects the actual moving position of the inner tube and is output in the form of DC voltage.
- (2) Power output can be used as the power supply for VR. There are two voltage specifications, which can be selected and set in the PC: 5 VDC or 10 VDC, max. 15mA
- (3) Position input: Input voltage makes the actuator run to the specified position, max. 10VDC input (Factory preset evenly distribute 0~10V to the full stroke defined by the software limits)
- (4) Dir. In/Dir. Out: Connect Pin ⑤ to Pin ④ (GND) to retract the actuator. And connect Pin ⑥ to Pin ④ (GND) to extend the actuator.
- (5) Stop input: The potential level is 'Normally High'. While Pin ⑤ is connected to Pin ④ (GND), it can be used as an signal input to stop the actuator.
- (6) Position OK output: It is Low potential (0 VDC) when moving, and High potential (3.3 VDC) when it is stopped and in position.
- (7) Error output: Normally at Low potential (0 VDC), it will become High potential (3.3 VDC) when an error occurs.
- (8) Learning:
 - CI74-D and CI74-P can directly trigger stroke learning by connecting Pin ⑦ to Pin ④ (GND) of the supplementary control terminal.
 - CI74-B cannot trigger stroke learning from the hardware. It can only be executed from the MOTECK CI74 PC tool or through Bus commands.



6.3.2 Behavior of Stroke Learning Function

When CI74 is performing stroke learning function, it will detect the limit position of the actuator, and the LED indicator will flash slowly at this time. (ON 1 second → OFF 1 second → ... Intermittent).

If the actuator is equipped with physical limit switches, the above reference position will be the software limit position learned;

If the actuator is not equipped with physical limit switches, after learning, it will retract 1% from the above-mentioned front reference position as the software limit position. The system will use the learned starting point as the stroke end limit in the retraction direction.

6.4 PC setting ports



Before using each CI74 for the first time, it is necessary to connect it to a PC using the PC setting cable for setting, and use the PC tool program provided by our company to complete the electronic installation and parameter setting (see section 8.1 & 8.2) before connecting to the host controller to start using it.

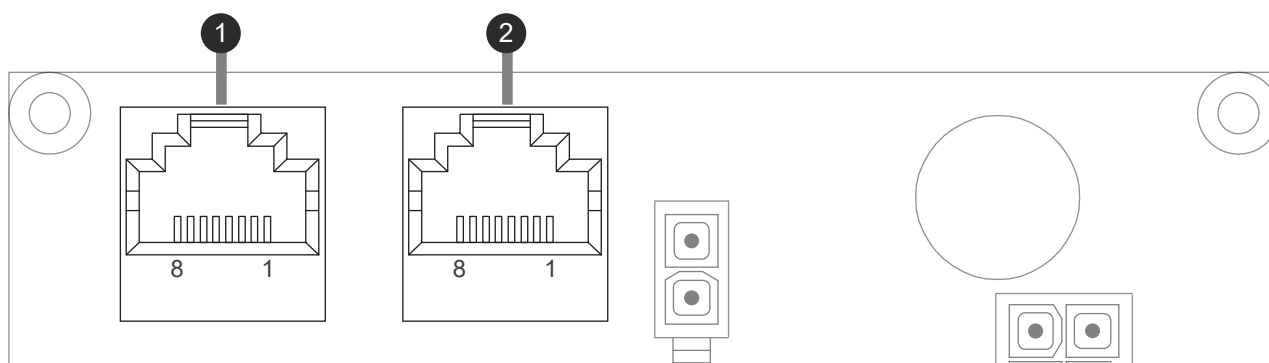

• Wire definition

Pin No.	8	7	6	5	4	3	2	1
Definition	Not used						RS485_A	RS485_B

• Connect to PC

Use a 1500mm long USB to RJ45 PC setting cable (Fig. 1), RJ45 is connected to the CI74 (port ① or ②), and USB is connected to the PC.

To purchase separately according to your needs, please consult MOTECK sales representatives.



Fig. 1 PC setting cable



6.5 Bus communication ports

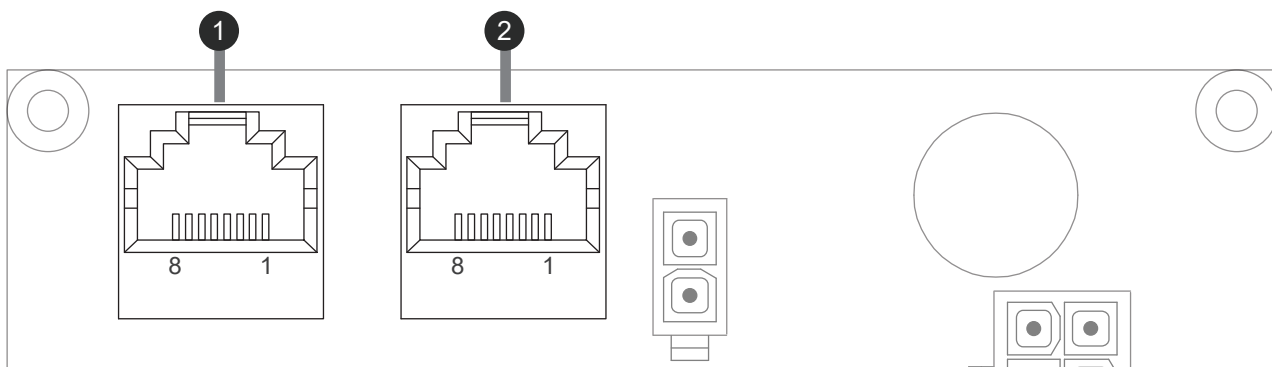

• Wire definition

Pin No.	8	7	6	5	4	3	2	1
Definition	Not used						RS485_A	RS485_B

• Connect to Modbus network

- (1) Connect each CI74 in series with CAT-5 (or above) communication cables with RJ45 connectors. Cables are prepared by customers.
- (2) If the CI74 is connected in series in a non-daisy chain topology, it is recommended to connect the first RJ45 (port ①) of the CI74.



- (1) Users are required to add terminating resistors at both ends of the Modbus trunk cable, which can effectively reduce reflections at the ends of the RS485 cable and reduce electrical noise interference. It is recommended to use a 120Ω resistor. If the end of the trunk cable happens to be a piece of CI74, you can use a commercially available terminating resistor (as shown in Figure 1, the resistor must be connected across Pin 1 & 2) and insert it into any of the two RJ45 sockets of the CI74. This accessory can also be purchased from our company, please contact your Moteck sales window.
- (2) It is theoretically possible to tap short branch lines from the bus trunk to connect additional devices, but it's not recommended to connect the CI74 to the bus in this way. However, if necessary, users can arrange to connect the RS485_A and RS485_B wires to the bus trunk according to the wiring definitions. With this connection method, terminating resistors are not required on the CI74 board. To minimize the impact of signal reflection, keep branch wires as short as possible and limit their number.



Fig. 1 Terminating resistor



6.6 Operation indicator



	Operation indicator	Description
●	Green indicator stays on	Actuator reaches the upper and lower endstop switches
⦿	Blinks green slowly	Learning
●	Red indicator stays on	Power-on
⦿	Blinks red slowly	Override





6.7 Setting Switches



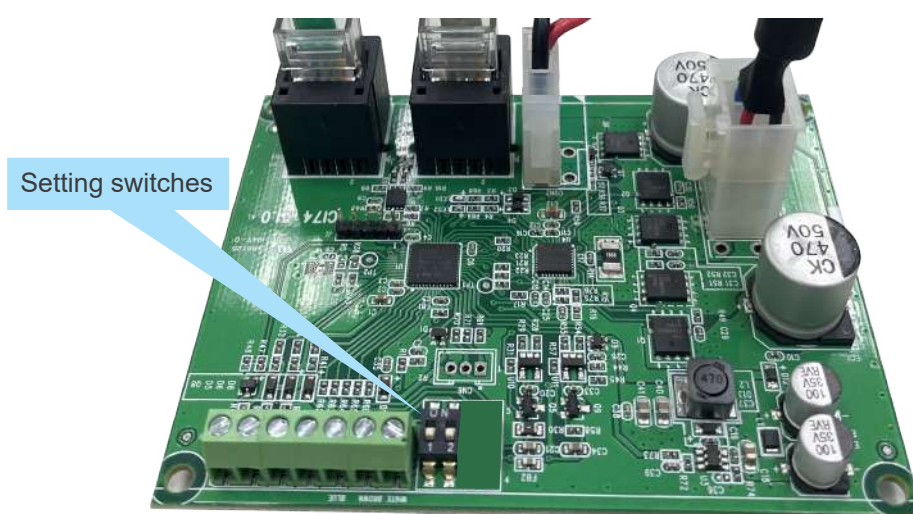

- For safety and correct setting, please confirm that each actuator and all necessary control input/output terminals are connected properly before turning on the input power.
- Please confirm the actuator specification before setting.
- The factory default position of DIP switches is OFF.



6.7.1 Lock / Unlock of setting function

Parameters	Set	DIP switch
Settings can be changed through PC tool programs. After setting is completed, be sure to switch it to OFF.	ON	
Lock (Default)	OFF	

6.7.2 Override

Parameters	Set	DIP switch
Disconnected from Modbus control	ON	
Connected to Modbus control	OFF	



7. Installation Steps / Operating Instructions

- (1) First, each CI74 must be individually connected to the PC using a PC setting cable and powered on. After checking the specifications of the actuator assigned to it, set the ID address of the individual actuator through the dedicated PC tool program provided by MOTECK. (See section 8.1)
- (2) Do not install the actuators mechanically first, but connect it to its assigned CI74. After executing the [Learning for actuator stroke] step through the PC tool program (See section 8.2) and completing the parameter settings, disconnect the CI74 from the PC for standby.
- (3) After completing the actuator configuration, connect the CI74 to the host controller with a CAT-5 (or above) communication cable. If it is a multi-actuator control system, please also connect other CI74. After completing the electronic installation and wiring first, then conduct the off-machine trial control before mechanical installation.
- (4) During the actuator is in motion, the LED indicator of the CI74 controller will keep flashing rapidly (4 times/second). When the actuator reaches the upper and lower limits, the LED indicator will stay on to indicate that it is in place. The LED indicator will be off when in the other positions.
- (5) After off-machine test OK, you can proceed with the mechanical installation; install each actuator on the application rack, and test running.
- (6) When the actuator needs to recalibrate, you can select to start the [Learning for actuator stroke] function directly through the control I/O terminal of the CI74 (See section 6.3) or reconnect the CI74 to the PC and execute [Learning for actuator stroke] with the PC tool program.



8. Moteck CI74 PC tool

Moteck CI74 PC tool is an application tool that runs on the computer Windows platform and is used to set parameters of CI74.

8.1 Basic setting

8.1.1 Automatic configuration

- (1) Open the application tool on the PC and enter the [Bus Devices] tab. After ticking the “Auto Select” in the “COMMUNICATION PORT” field, it will automatically search for the currently plugged-in port or users can select from the drop-down menu of “ComPort”.
- (2) The default Baud Rate is 115200. If you need to set or check the Baud Rate, turn the position #1 of the setting switches on CI74 to “ON” before powering on (see section 6.7.1)
- (3) Click the “Connect” button to activate the selected communication port.
- (4) Click the “Scan Devices” button to scan out the Device ID and model of the CI74 connected to the communication port. Click the “Stop Devices” button to stop scanning, or scanning will end automatically when it reaches Device ID 127.
- (5) After the scan is completed, click the ID in the “DEVICE INFO” field to display the Firmware version of the CI74.

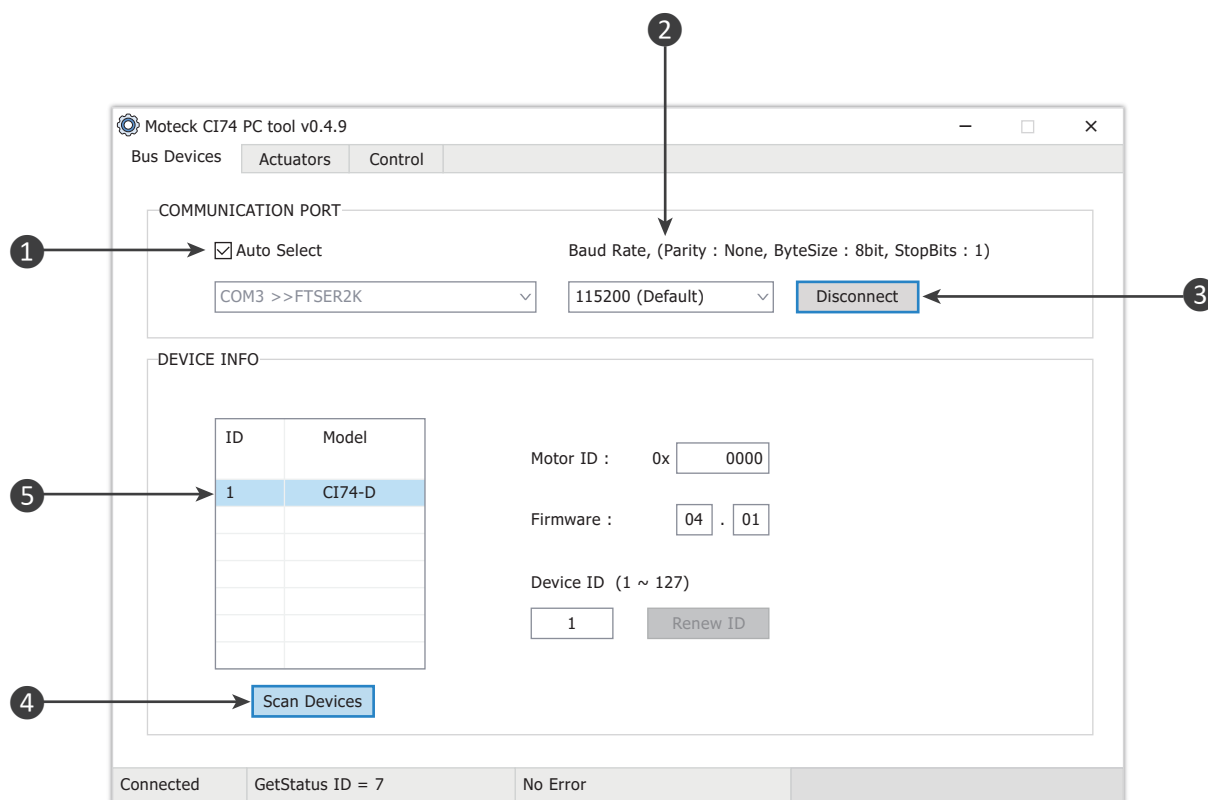

8.1.2 Change device ID

- (1) Click the Device ID you want to change.
- (2) Enter a new ID in the "Device ID" input box (valid range 1~127).
- (3) Click the "Renew ID" button and a prompt window "Update device ID (Address) success fully!" will pop up, indicating that the write is successful.

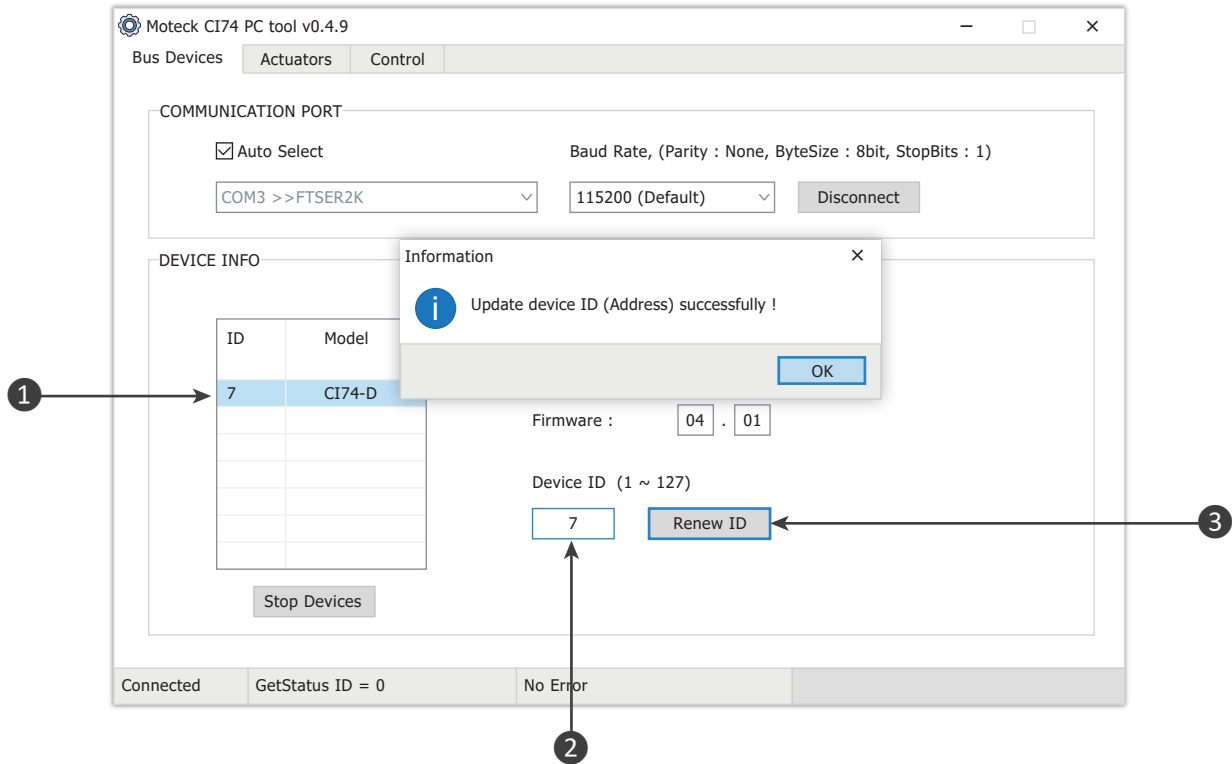

8.2 Configuration of actuator parameters

Click the Device ID in the [Bus Device] tab, and the setting interface for the ID will be displayed in the [Actuator] tab. For example, if you select ID 7 in the [Bus Device] tab, the device ID will be displayed as 7 in the [Actuator] tab.

The screenshot displays the 'Moteck CI74 PC tool v0.4.9' software interface. The 'Actuators' tab is active, showing a configuration window for Device ID 7. The interface includes several sections for parameter configuration:

- CONFIGURATION**
 - Device ID:** A text box containing the number '7'.
 - Hall sensor:** Radio buttons for 'Single' and 'Dual'.
 - Limit switch:** Radio buttons for 'Yes' and 'No'.
 - Hall Pot (Volt.):** Radio buttons for '0.5 ~ 10' and '0.5 ~ 5'.
 - Baud Rate (Serial port settings : None, 8, 1):** Radio buttons for '115200', '4800', '9600', and '19200'.
 - Stroke:** A text box followed by '(Steps)' and a 'Learn' button.
 - Front limit:** A text box followed by '(Steps)'.
 - Rear limit:** A text box followed by '(Steps)'.
 - Motor speed:** A text box followed by '(PWM %, 10 ~ 100)'.
 - Over load protect:** A text box followed by '(mA) (3000 ~ 15000)'.
- File:** A panel containing 'Import' and 'Export' buttons.
- Buttons:** 'Read' and 'Write' buttons are located to the right of the configuration options.

At the bottom of the window, a status bar shows: 'Connected', 'GetStatus ID = 0', and 'No Error'.



8.2.1 Learning for actuator stroke

- (1) According to the actuator connected to the CI74, select the correct specification in the "CONFIGURATION" field of the [Actuators] tab. This includes selecting whether the position signal feedback uses a single or dual Hall sensor ('Hall sensor' box), whether the actuator has a limit switch ('Limit switch' box), and the voltage output range representing the actuator's analog position information ('Hall Pot' box). Additionally, set the system's Baud Rate.
- (2) Click the "Learn" button to perform stroke learning. After learning is completed, the actuator's stroke, upper limit, lower limit, motor speed, overcurrent protection, and other values are displayed.

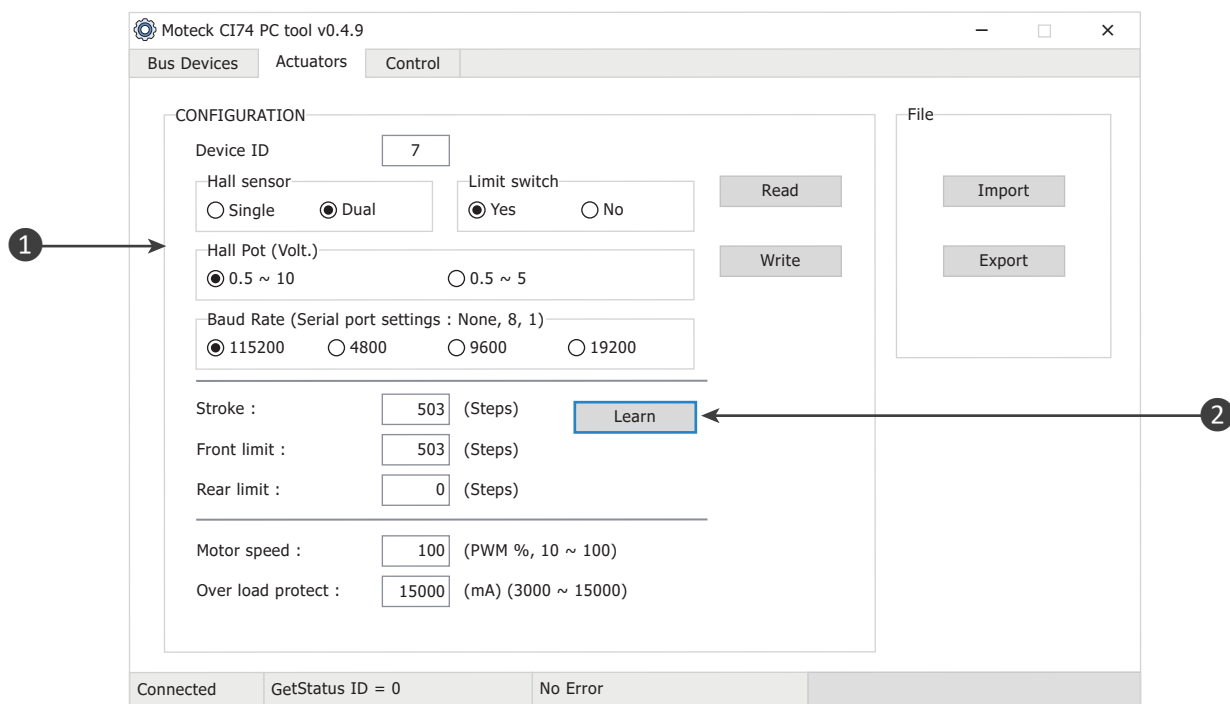

If the actuator is not equipped with a limit switch, the actuator must be retracted to its lowest point before learning the stroke. The system will use the starting point of learning as the lower limit.



8.2.2 Configuration for CI74-D & CI74-B

- (1) After completing the stroke learning, you can change the stroke, upper limit, lower limit, and motor speed (in terms of percentage) in the input boxes according to your needs. You can also enter the overload protection value (i.e. electric current between 3000~15000 mA) and change it if necessary.
- (2) After changing the parameters in the field, click the “Write” button, and the prompt window “Update device config successfully!” will pop up, indicating that the write is successful, that is, the CI74 settings of the selected Device ID is updated.

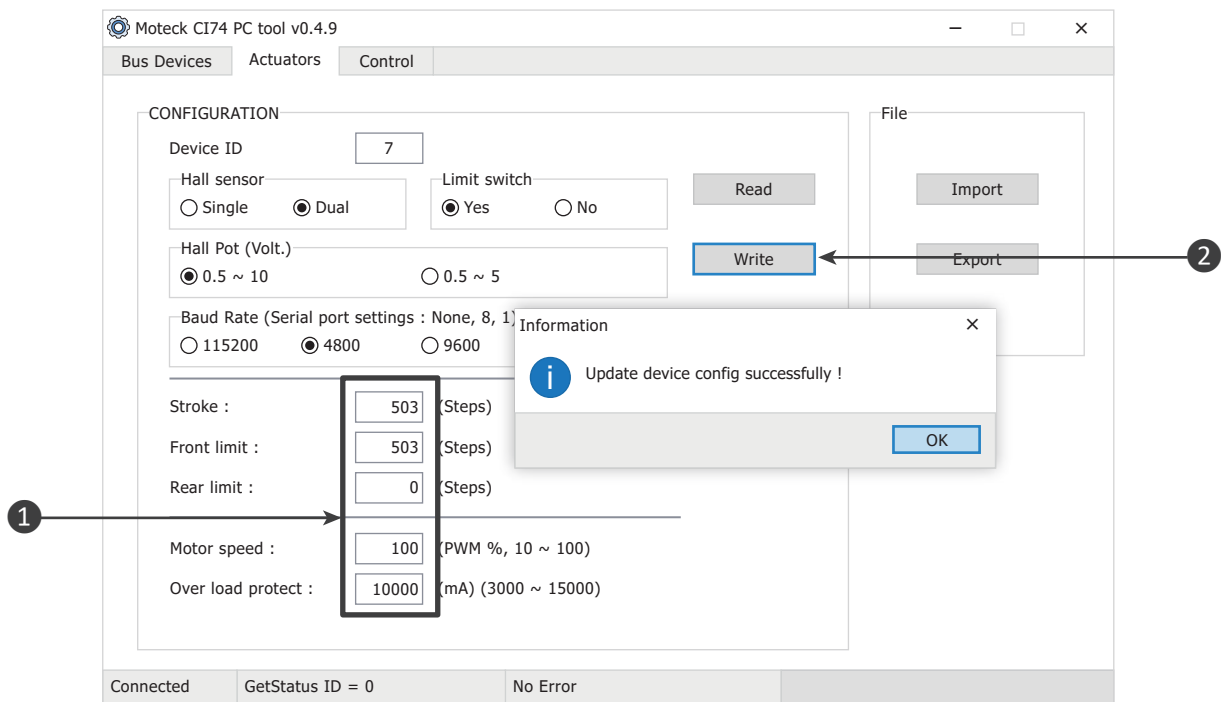

The upper limit value cannot exceed the stroke value.



8.2.3 Configuration for CI74-P

- (1) After completing the stroke learning, you can change the stroke, upper limit, lower limit, and motor speed (in terms of percentage) in the input boxes according to your needs. You can also enter the overload protection value (i.e. electric current between 3000~15000mA) and change it if necessary.
- (2) Select in box "Voltage out" (5.0V or 10.0V) to set the reference output voltage of supplementary control I/O terminal number 2 . A variable resistor can be connected in series as the analog position input of terminal number 3 to control the action of the actuator (section 6.3.1).
- (3) In the end of configuration process, click the "Write" button, and the prompt window "Update device config successfully!" will pop up, indicating that the write is successful, that is, the CI74 settings of the selected Device ID is updated.

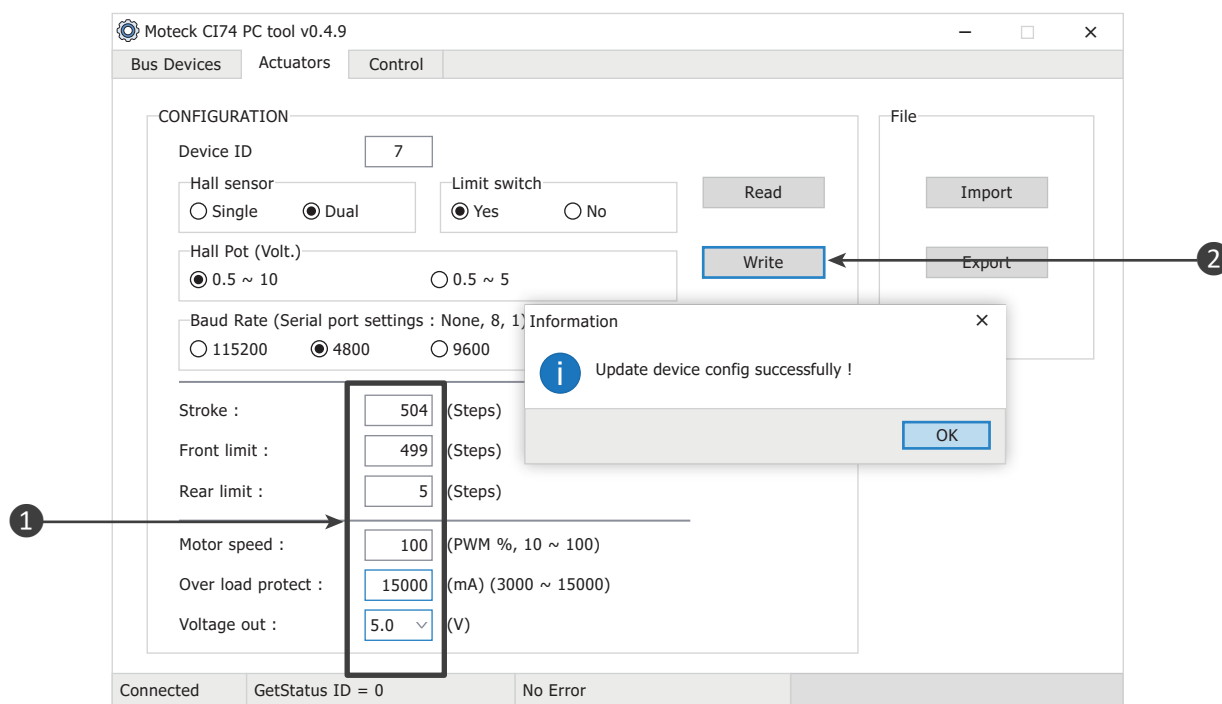

- The upper limit value cannot exceed the stroke value.
- The box of "Voltage out" is selectable to a reference voltage output at terminal number 2 of supplementary control I/O. Its rated current is only 15mA, so it may not be suitable for other uses.



8.3 Parameters management function

8.3.1 Read

If this CI74 has been configured before, click the “Read” button in the “CONFIGURATION” field under the [Actuators] tab to load the previous parameters for display on the application screen. And a prompt window “Get device config successfully!” will pop up, indicating that the read of the previous parameters is successful.

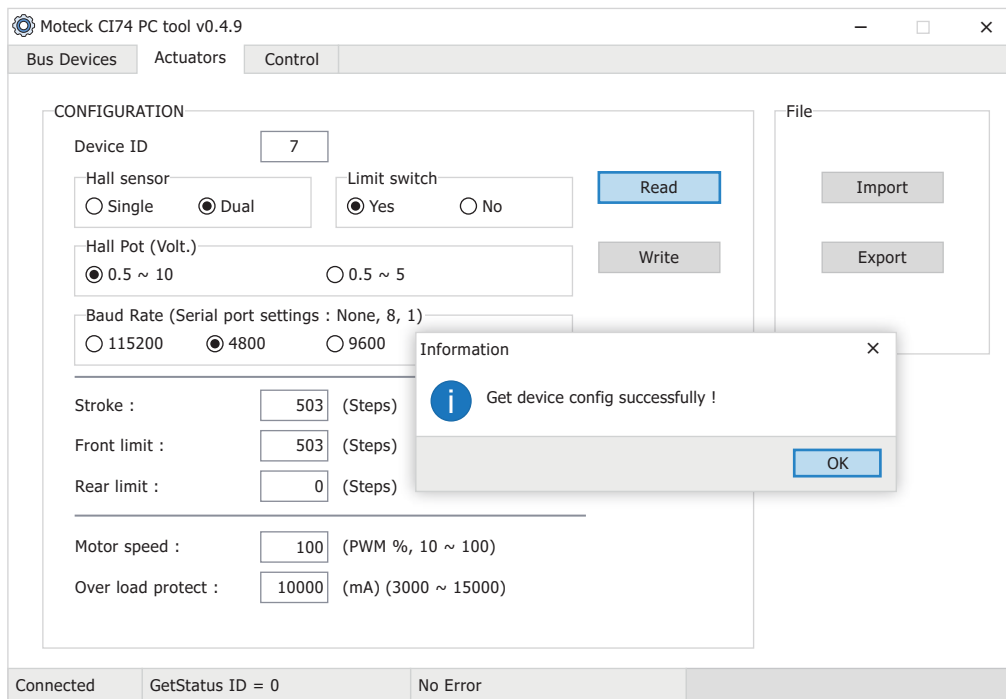

8.3.2 Export

(1) In the “File” field, click the “Export” button to export the current parameters into a file.

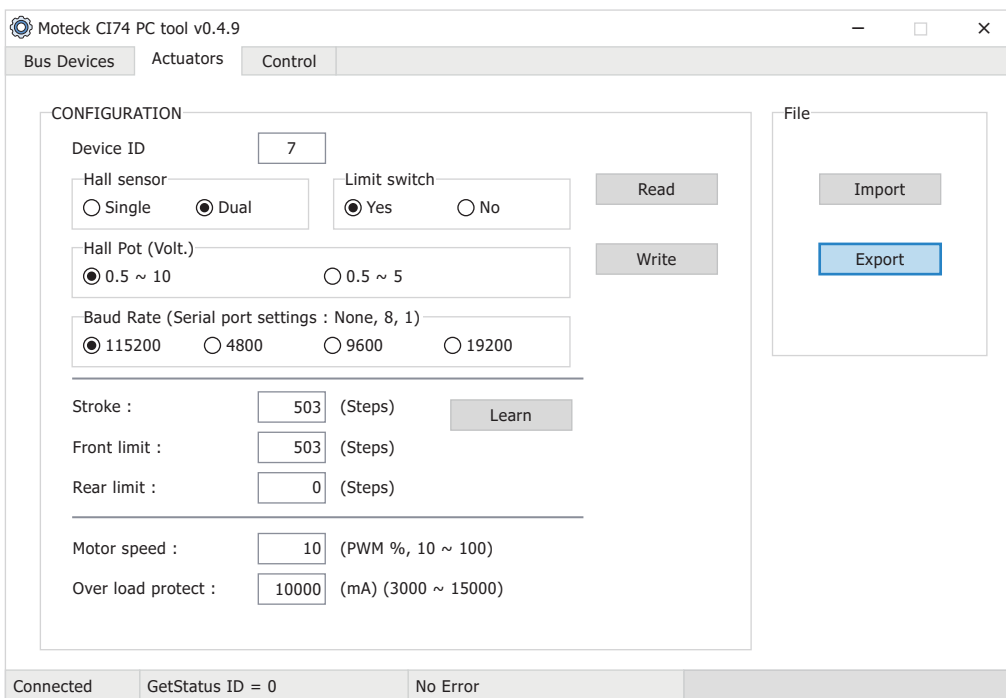

- (2) The exported file name and extension (.config) will be automatically generated. Please do not modify the file extension. Only files with the same format will be recognized during import.

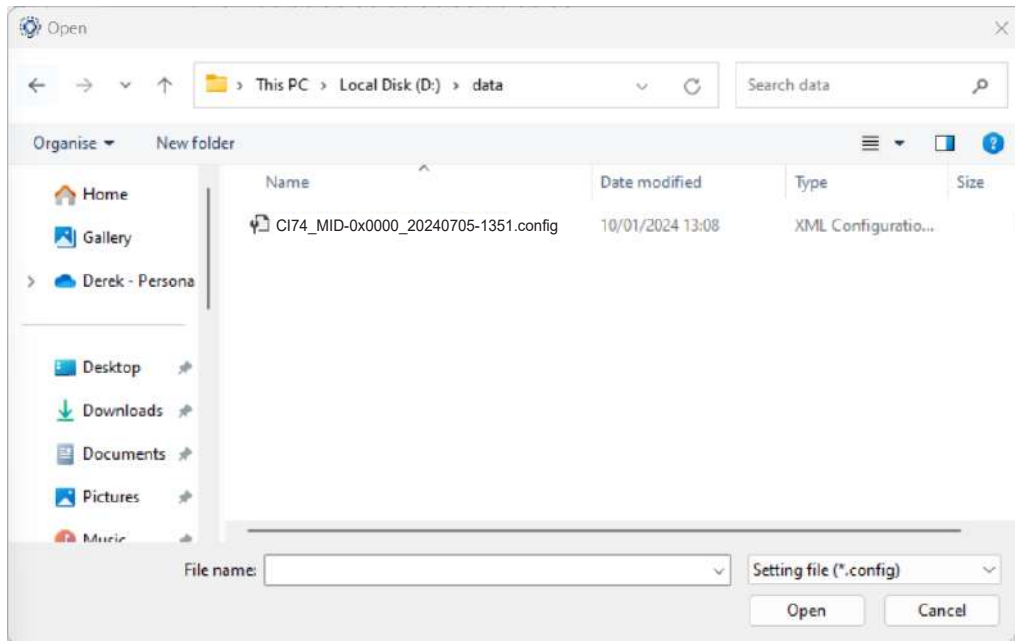

8.3.3 Import

- (1) Click the "Import" button In the "File" field.

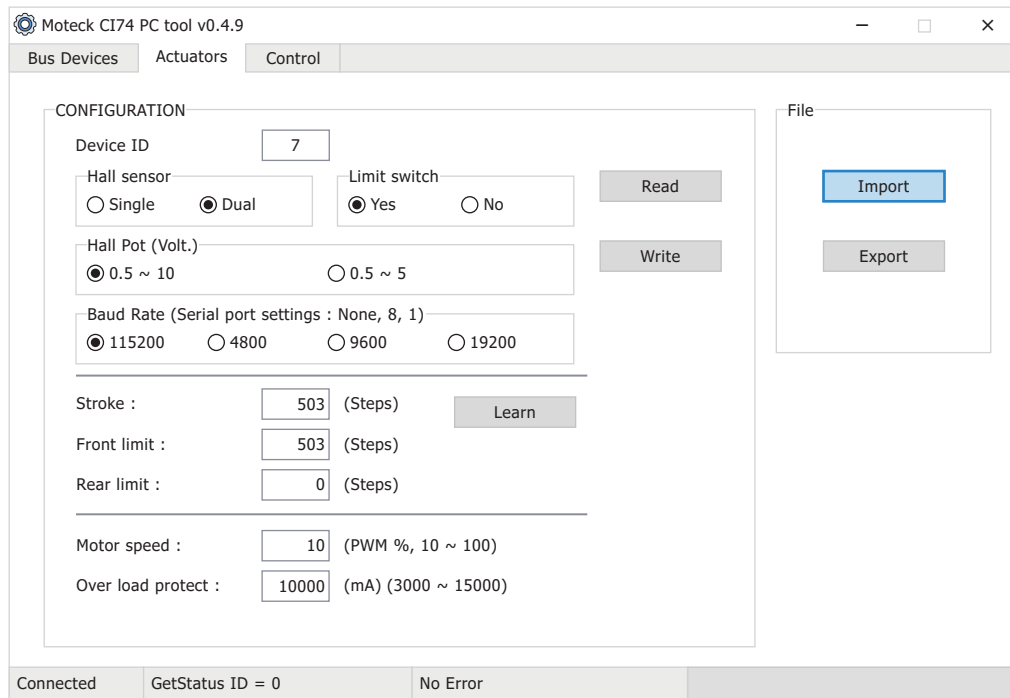

- (2) Select the correct configuration file through the path on the PC, and click 'Open' to import the parameters stored in the file into the application and display them on the screen.

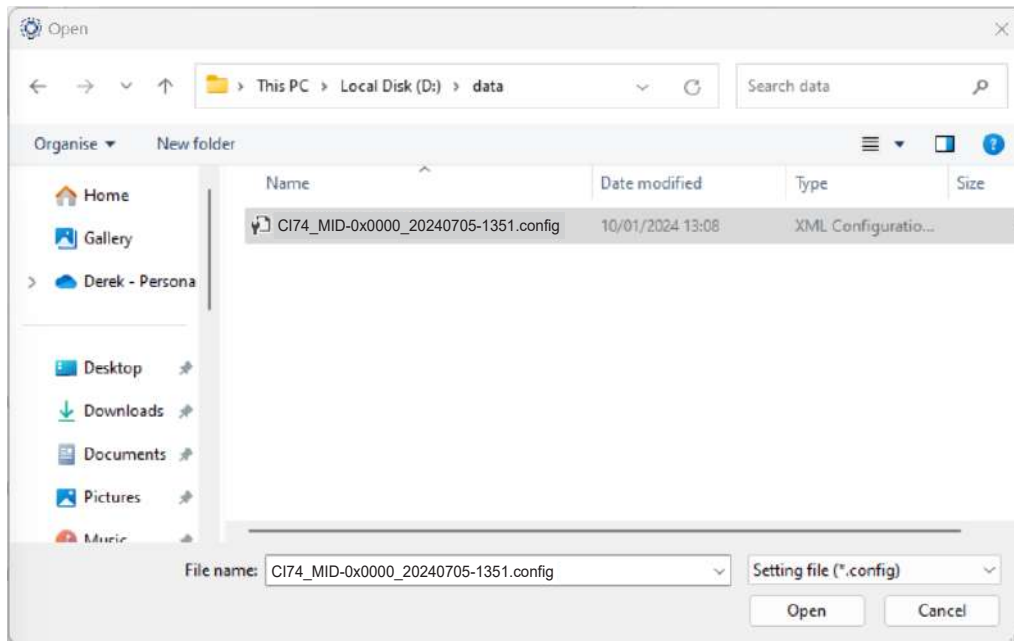

- (3) Click the "Write" button to write the parameters displayed on the screen into CI74. After completion, a prompt window "Update device config successfully!" will pop up, indicating that the writing is successful and the purpose of importing the previous parameters is completed.

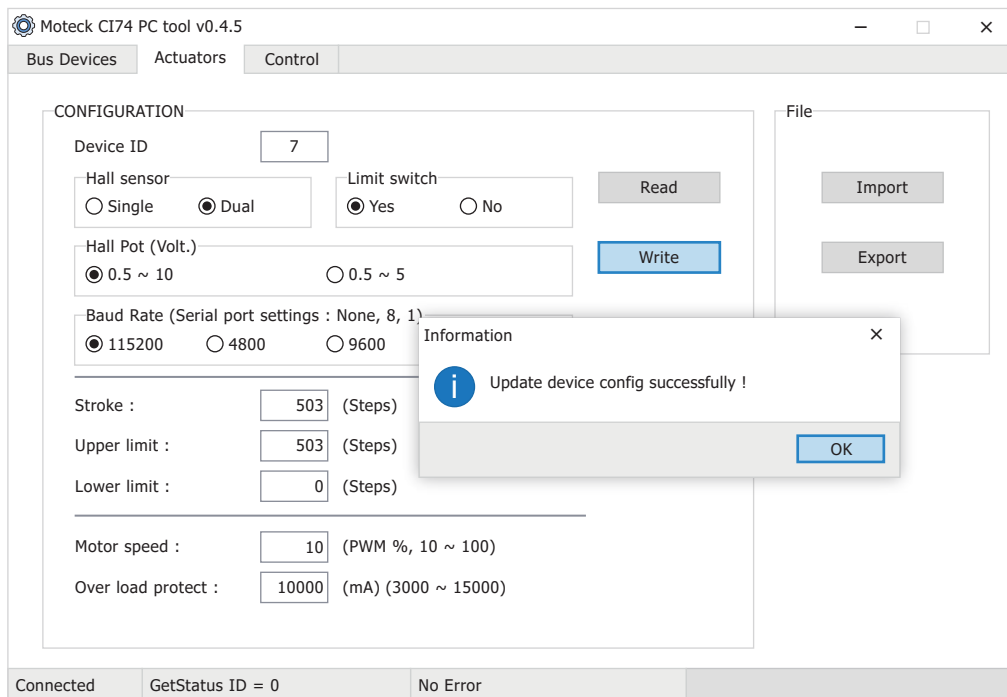

8.4 Control function

8.4.1 For CI74-D or CI74-B

- (1) In the “Select Device” field of the [Control] tab, click the actuator you want to control.
- (2) The actuator can be moved forward and backward through the control keys. Input the position in the box of the “Target Pos”, and then click the “Go” button, the actuator will move to the specified position. The actuator status can be read in the “Status” field.

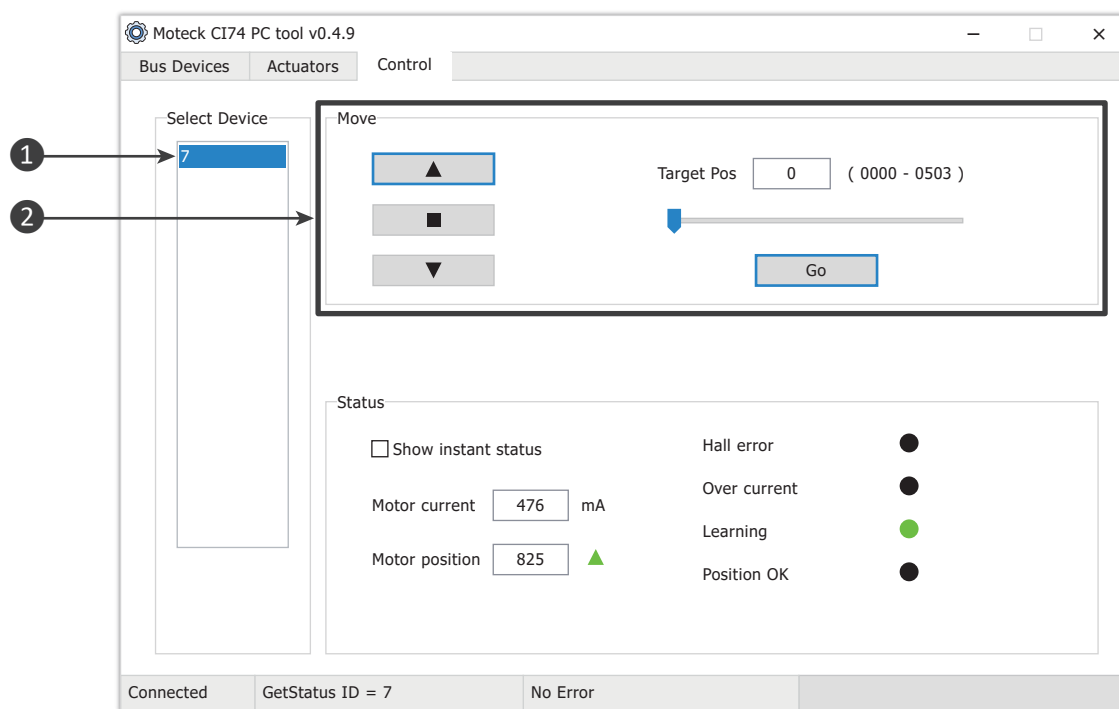

8.4.2 For CI74-P

- (1) The CI74-P control function is not available in the "Move" field of the [control] tab. However, the actuator can be moved forward or backward through the supplementary control I/O terminal, and the status of the actuator can be read by this application tool.
- (2) Click on the actuator in the “Select Devices” field. Check “Show instant status” in the “Status” field to read.

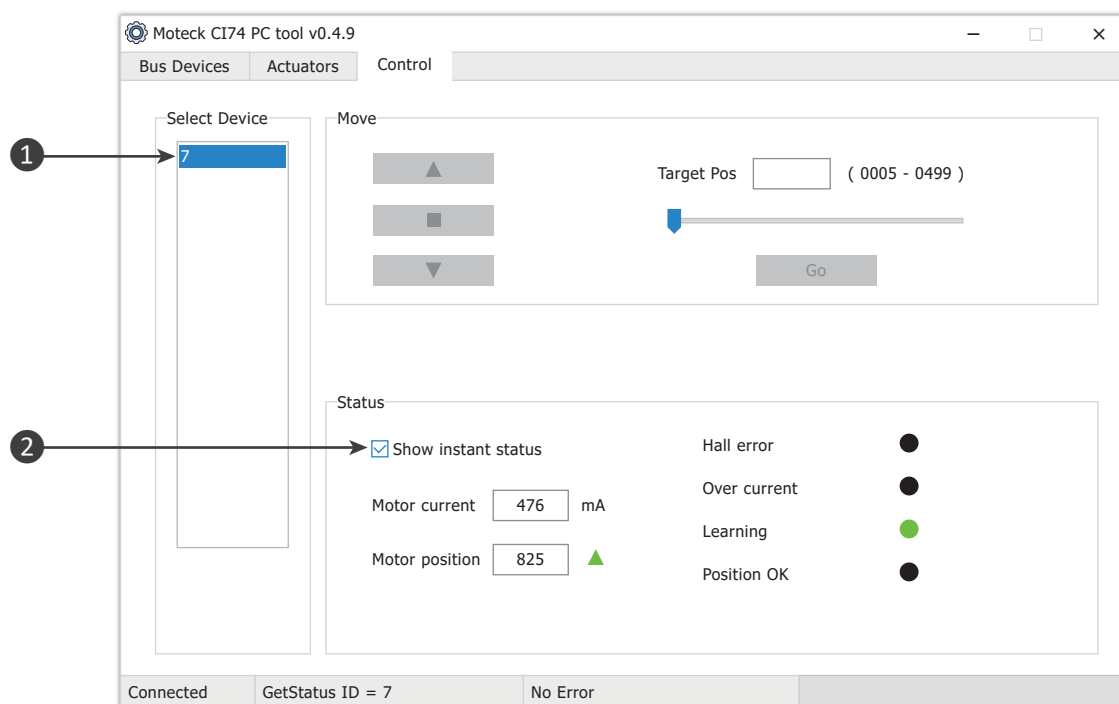

9. Modbus Protocol

9.1 General information

- (1) Please use terminating resistors on the Master and the farthest end of the line. It can effectively reduce the reflection at the end of the RS485 cable and reduce the interference of electrical noise. It is recommended to use a 120Ω resistor (refer to section 6.5).
- (2) Theoretically, Modbus can support up to 247 nodes. This is because the address range of the Modbus protocol is from 1 to 247. As for the number of devices, it depends on the physical layer protocol used, with limitations related to bus load and hardware. The RS485 standard usually supports up to 32 devices. The maximum number of devices in actual applications will be affected by the following factors:
 - Transmission rate (The baud rate)
 - The total length of the trunk cable and the derivation cables
 - The quality of the cabling
 - The functionality of the device, especially about the poll rate.
- (3) Modbus parameter values supported by CI74

Parameter list	Parameter value	Default
Addressing	Configurable from 1 to 127	1
Baud rate	4800, 9600, 19200, 115200	115200
Data bits	8 bits	8 bits
Parity	None	None
Stop bits	1	1
Mode	Modbus	Modbus



9.2 Message Formats

Modbus messages consist of four fields: Address field, function field, data field and CRC field, and there is a minimum silent interval before the start of the message and after the end of the message. A new message can start after this interval. In the structure of the message format, the length of the message data field will vary depending on the situation, while the length of other fields is fixed, as shown in the figure below.

Byte 0	Byte 1	Byte 2 .. N	Byte N+1, N+2
Address	Function	Data	CRC

• Address Field

The length of this field is one byte, and the valid range is 1~246, representing different CI74 device addresses. 0 is a broadcast address, and devices at all addresses will receive this message, while 247~255 are reserved for special purposes. There are two modes for sending and receiving messages, including unicast and broadcast modes. Each device should be assigned a unique address so that the controller can send messages to a specific device in unicast mode.

(1) Unicast:

That is a one-to-one communication model. The address field of the message specifies a single device address that receives this message, which represents the Device ID configured in Moteck CI74 PC Tool. Only CI74 matching this address will accept this message and respond when completed.

(2) Broadcast:

This is a communication mode for controlling multiple CI74s from one control. The address field of the message uses 0x00 to represent the broadcast address. Function code 06 can be used in broadcast mode to send a request to write single holding register. All CI74s connected on the bus will accept and execute this write request, but will not respond to any message. However, the broadcast mode is not applicable to the Read function (function code 03, 04), and CI74 will not respond to any Read request in broadcast mode.



• Function Field

It is also a byte used to specify the type of command sent by the controller, such as reading data or writing data. The function codes supported by CI74 include three function codes: 03 (0x03), 04 (0x04), and 06 (0x06), which are introduced below.

CI74 will respond to the message with the same function code, indicating success. If an error occurs, an exception message indicating the error will be returned (see section 9.4).

(1) Function code 03 (0x03): Read Holding Registers (HR)

Used to read the stored data from the holding register of CI74, if the controller inquires about a valid holding register, CI74 will respond with a normal message including the requested data.

The format of such message is as follows:

Request:

Address	Function	Register address		Register count		CRC	
Device Address	03	Starting Address Hi	Starting Address Lo	Quantity of Register Hi	Quantity of Register Lo	CRC Lo	CRC Hi

Response:

Address	Function		Data		CRC	
Device Address	03	Byte count	Data Byte 1 .. N		CRC Lo	CRC Hi

(2) Function code 04 (0x04): Read Input Registers (IR)

Used to read the stored data from the input register of CI74, if the controller asks for a valid input register, CI74 will respond with a normal message including the requested data.

The format of such message is as follows:

Request:

Address	Function	Register address		Register count		CRC	
Device Address	04	Starting Address Hi	Starting Address Lo	Quantity of Register Hi	Quantity of Register Lo	CRC Lo	CRC Hi

Response:

Address	Function		Data		CRC	
Device Address	04	Byte count	Data Byte 1 .. N		CRC Lo	CRC Hi



(3) Function code 06 (0x06): Write Single Holding Register

This function is used to write new values to a single Holding Register of the CI74. If the controller requests a write to a valid Holding Register, CI74 will respond with a normal message after completion. The normal response is just to return the request message. The format of such message is as follows:

Request:

Address	Function	Register address		Register data		CRC	
Device Address	06	Address Hi	Address Lo	New value Hi	New value Lo	CRC Lo	CRC Hi

Response:

Address	Function	Register address		Register data		CRC	
Device Address	06	Address Hi	Address Lo	New value Hi	New value Lo	CRC Lo	CRC Hi

- **Data Field**

This field contains the specific data that the controller needs to pass to the CI74, such as the register address to be read or written, the quantity, and the data itself.

This causes the length of the message data fields to vary depending on the situation. The application information passed between the controller and the device (i.e. CI74) is organized into one or more 16-bit registers, and different data types will correspond to these addressable registers. Any parameter value type embedded in a Modbus message must be identified from the register table. (see section 9.3)

- **CRC Field**

The length is two bytes and is used to verify the integrity of the message. The transmitting device will calculate the CRC value and attach it to the message end. The receiving device will recalculate the CRC, if the two do not match, it will determine that the message is incorrect and return an error message.

9.3 Register table and application examples

Any type of parameters embedded in a Modbus message must conform to the definition of the register table. Data can be read or written from the Holding Register (HR), while the data of the Input Register (IR) can only be read. Its address and representative parameters are defined as follows.



9.3.1 Parameter list of Holding Register

Register address	Item	Description	Range (16 bit data)	Default	Remark
0x0F	Device Address	Device ID of CI74	1~127	1	0 is the broadcast address
0x1F	Current Position	Hall counts of the current stroke position of the actuator	00~0xFFFF	0	In units of Hall pulse counts
0x20	Max. Position	Hall counts of the maximum stroke of the actuator	00~0xFFFF	0	In units of Hall pulse counts
0x21	Rear Limit	Hall counts of the retraction stroke limit of the actuator	00~0xFFFF	0	In units of Hall pulse counts
0x22	Front Limit	Hall counts of the extension stroke limit of the actuator	00~0xFFFF	0xFFFF	In units of Hall pulse counts
0x23	Motor Current Limit	Overcurrent protection limit of the connected actuator	00~0xFFFF	0x3A98	Default=15,000mA
0x24	Motor Speed PWM	PWM Duty of the connected actuator	10~100	0x0064	Default=PWM 100%
0x25	Command In ⁽¹⁾	Request actuator movement (Forward / Backward / Stop / Learn / Goto)	1~5	0	
0x26	Goto Position (Set)	A preset Goto target position	00~0x7FFF	0	Default=Retract to shortest position
0x27	Actuator Setting ⁽²⁾	Actuator Hall sensor and limit switch configuration	0x00, 0x01, 0x02, 0x03	00	Default=Dual Hall & without limit switch
0x2B	Hall POT Select ⁽³⁾	Analog position output range of the actuator (0.5~10V / 0.5~5V)	0, 1	0	Default=0.5~10V
0x2C	Baud Rate Select ⁽⁴⁾	115200 / 4800 / 9600 / 19200	0~3	0	Default=115200

Notes:

⁽¹⁾ Command In

Item	Value
None	0
Forward (Move)	1
Backward (Move)	2
Stop	3
Learn	4
GOTO Position (Move)	5

⁽²⁾ Setting

Item	Value
BIT0: Hall sensor	0: Dual
	1: Single
BIT1: Limit switch	0: No limit switch
	1: With limit switch

⁽³⁾ Hall POT Select

Item	Value
0.5 ~10v	0
0.5 ~ 5v	1

⁽⁴⁾ Baud Rate Select

Item	Value
115200	0
4800	1
9600	2
19200	3



9.3.2 Parameter list of Input Register

Register address	Item	Description	Range (16 bit data)	Default	Remark
0x3F	Motor Status	The status of the actuator (Stop / Forward / Backward)	(Refer to Note A)	0	
0x40	System Status	System status of the actuator	(Refer to Note B)	0	
0x41	Motor Current	Current of the atuator	00~0xFFFF(mA)	N/A	
0x42	Hall D/A	The D/A value that is stored in Input Register. It can be converted to the analog position value of the actuator.	0~FFF (Note C)	N/A	
0x43	VR In A/D	The A/D value that is stored in Input Register. It can be converted to the target position of the previous VR input voltage (for controlling the actuator action)	0~FFF (Note D)	N/A	
0x44	System Voltage	The A/D value converted from the system voltage of the connected actuator	0~FFF	N/A	$V(\text{volt}) = A/D \times 3.3 \times 92 / 20480$
0x45	Version No	The firmware version of CI74	0x0101~0x9999	1.01~99.99	
0x46	CI74 Type	The function version of CI74	(Refer to Note E)	Refer to Note E	

Notes:

Note A. Motor Status

Item	Value
Motor stop	0
Motor forward	1
Motor backward	2

Note B. System Status

Item	Value
BIT4	1: Hall Error
BIT5	1: Motor Over Current
BIT6	1: In Learning
BIT7	1: In Go Position

Note C. Conversion formula:

Hall Pot voltage = D/A value (in decimal) x (Set maximum range -0.5) / 4096 + 0.5

And

The current position = (Hall Pot voltage / Set maximum range) x Total stroke length

Note D. Conversion formula:

VR input voltage = A/D value (in decimal) / 4096 x VR Maximum range voltage

And

The target position = VR input voltage / VR Maximum range voltage x Total stroke length

Note E. CI74 Type

Item	Value
CI74-D	0
CI74-P	1
CI74-B	2



9.3.3 Application examples

The following examples are typical user scenarios and corresponding message parameters.

Example 1

Request to read CI74 device address (Device ID) No. 3. What is the current motor status of the actuator connected to it?

Request:

Field Name	Hex	Description
Address	03	Recipient of this request
Function	04	Read Input Registers
Starting Address Hi	00	Input Register 0x003F
Starting Address Lo	3F	
Quantity of Register Hi	00	
Quantity of Register Lo	01	

Response:

Field Name	Hex	Description
Address	03	Sender of this response
Function	04	Read Input Registers
Byte count	02	The actual number of data bytes of the message
Data 1	00	Read parameters (0x0000=Motor stop)
Data 2	00	



Example 2

Request to read CI74 device address (Device ID) No. 3. What is the current position of the actuator connected to it?

Request:

Field Name	Hex	Description
Address	03	Recipient of this request
Function	03	Read Holding Registers
Starting Address Hi	00	Input Register 0x001F
Starting Address Lo	1F	
Quantity of Register Hi	00	
Quantity of Register Lo	01	

Response:

Field Name	Hex	Description
Address	03	Sender of this response
Function	03	Read Holding Registers
Byte count	02	The actual number of data bytes of the message.
Data 1	00	Read parameters (=0x0005 signal pulses)
Data 2	05	

Example 3

Request the CI74 device address (Device ID) No. 3 to run the actuator forward.

Request:

Field Name	Hex	Description
Address	03	Recipient of this request
Function	06	Write Single Holding Register
Address Hi	00	Holding Register 0x0025
Address Lo	25	
New Value Hi	00	Actuator extends
New Value Lo	01	

Normal response message: Same format and content as above



Example 4

Use a broadcast to request all connected CI74s to immediately stop their actuators from moving.

Request:

Field Name	Hex	Description
Address	00	All devices (broadcast mode)
Function	06	Write Single Holding Register
Starting Address Hi	00	Holding Register 0x0025
Starting Address Lo	25	
Quantity of Register Hi	00	Actuator stops action
Quantity of Register Lo	03	

No response message (for Broadcast request)



Example 5

Request the CI74 device address (Device ID) No. 3 to move the actuator to the position of Hall positioning pulse 250.

Step 1. Set GOTO position

Request:

Field Name	Hex	Description
Address	03	Recipient of this request
Function	06	Write Single Holding Register
Address Hi	00	Holding Register 0x0026
Address Lo	26	
New Value Hi	00	Write actuator moves to target position 0x00FA (=250)
New Value Lo	FA	

Normal response message: Same format and content as above

Step 2. Execute GOTO (Move)

Request:

Field Name	Hex	Description
Address	03	Recipient of this request
Function	06	Write Single Holding Register
Address Hi	00	Holding Register 0x0025
Address Lo	25	
New Value Hi	00	GOTO (Move) command
New Value Lo	05	

Normal response message: Same format and content as above



The actual actuator stroke length corresponding to the number of Hall positioning pulses will vary depending on the model or option of the actuators.

For the conversion methods, please refer to the actuator's data sheet on MOTECK official website or consult MOTECK sales representatives.

9.4 Exception message

In the Modbus protocol, when the controller sends an incorrect request, the device will respond with an exception message. The fields are as follows, including a 1-byte length exception code:

Address	Function	Error	CRC	
Device Address	Function Code +0x80	Erroe Code		

Exception message are:

Exception code	Definition	Description
0x01	Invalid function	The host requested a function code that the device does not support.
0x02	Illegal data address	The register address requested by the host does not exist in the device or cannot be accessed.
0x03	Illegal data value	The data value sent by the host is invalid, may be beyond the acceptable range of the register, or may not conform to the register format.
0x04	Device failure	The device encountered an internal error while performing the requested operation and was unable to complete the operation.



Terms of Use

The user is responsible for the suitability of MOTECK products, and the products listed on the MOTECK website are subject to change without notice. MOTECK reserves the right to terminate sales or delete any products displayed on the website or listed in its catalog.

